



1-877-280-4485

www.WateringMadeEasy.com

For Customer Service, please call 1-877-280-4485 or email help@WateringMadeEasy.com



WATERING MADE EASY SPRINKLER STATION SQUARED™ STEP BY STEP INSTALLATION GUIDE

What you'll need:

1. Watering Made Easy Kit
 - a. Sprinkler assembly
 - b. Female "quick connect"
 - c. Connection Protection Shell and Cover
 - d. Twine for determining sprinkler location
 - e. Step by Step Installation Guide

*IF ANY OF THE ABOVE ITEMS ARE DAMAGED OR NOT INCLUDED IN THE BOX, PLEASE CALL 1-877-280-4485

2. Shovel
3. Hand shovel/trowel
4. Extra dirt to fill the hole, if needed
5. Garden hose – water supply at 30 psig, 0.86 gpm

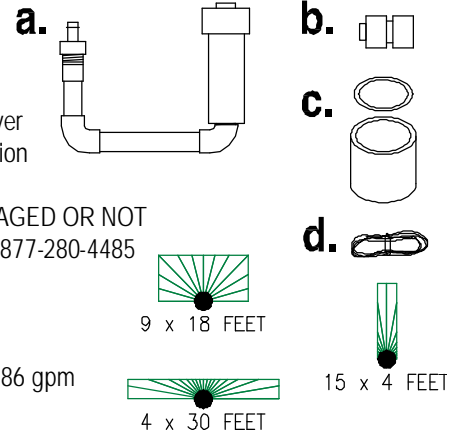

1. PLAN WHERE TO PLACE THE SPRINKLER STATION

Use the 15 foot long twine included with this kit to help you determine where to locate the sprinkler(s).

- a. Have a friend hold one end of the twine where you think a sprinkler should be placed.
- b. Hold the other end of the twine and walk so the twine is tight. Use the twine to estimate the distances and patterns available with this sprinkler. The Sprinkler Station Squared does not reach 15 feet in every direction.

2. PLAN THE DIRECTION AND PATTERN OF SPRAY

* PLAN ONLY AT THIS STEP. Actually set the sprinkler during installation.

- a. Sprinkler Station Squared™ can mist a 9 x 18 foot rectangle, a 4 x 15 rectangle or a 4 x 30 foot rectangle.
- b. Plan to spray away from the hose connection.
- c. Plan which rectangle you would like to spray.



TIPS:

- a. Place Sprinkler Station on the perimeter spraying inward to the target area.
- b. Place the hose connection minimum of 1 foot from a fence or other boundary.

TYPICAL LAYOUTS

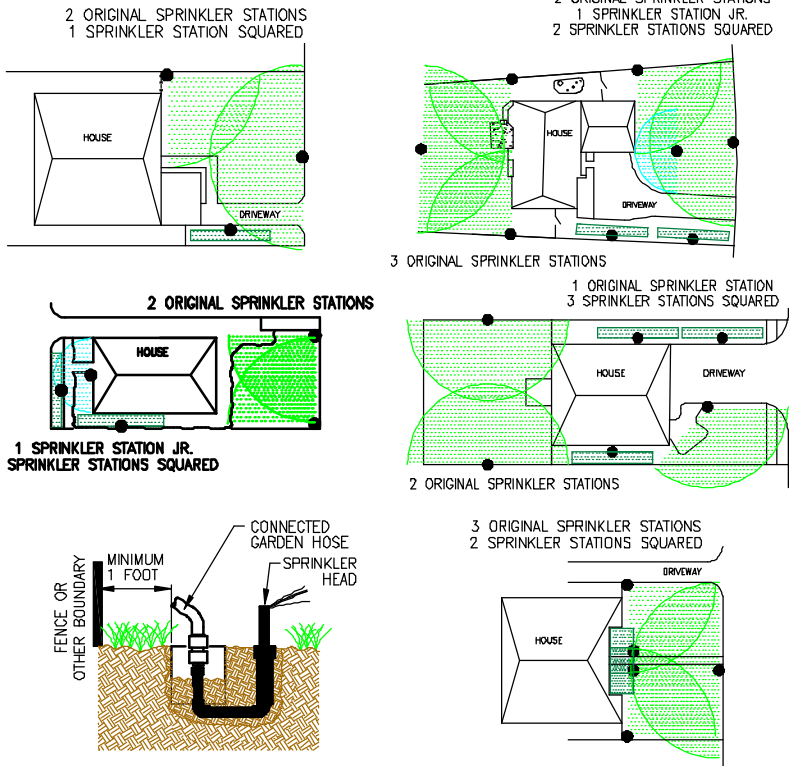

3. Dig a hole in the lawn where you would like the sprinkler.



TIPS:

- a. Start the hole by cutting straight down with a shovel all the way around and then remove the dirt.
- b. Place dirt into a box or a bucket to make it easy to refill the hole.

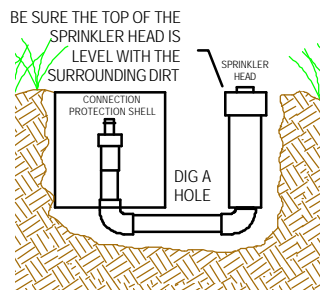

Use the Sprinkler and Connection Protection Shell as a guide to determine the size and depth of the hole.

4. Place the sprinkler into the hole.

- a. Fill the hole with about halfway with dirt
- b. Center the connection protection shell around the hose connection, level with the surrounding dirt
- c. Fill the hole, including inside the connection protection shell with another inch of dirt and pack tightly. *Be careful not to get dirt inside of the hose connection.
- d. Top off the inside of the connection protection shell with about 1/2" of gravel if available and place the cover on the connection protection shell.

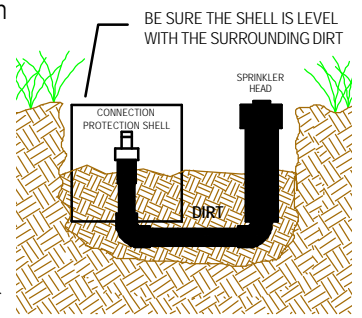

(CONTINUED)



**WATERING MADE EASY
SPRINKLER STATION SQUARED™
STEP BY STEP INSTALLATION GUIDE**

5. Fill the hole the rest of the way with dirt and pack tightly.

- Do not fill the connection protection shell with dirt.
- Pack dirt firmly all the way around the sprinkler head including the bottom and the connection protection shell.
- Pack the dirt tightly. You can step on the dirt around the sprinkler to pack it

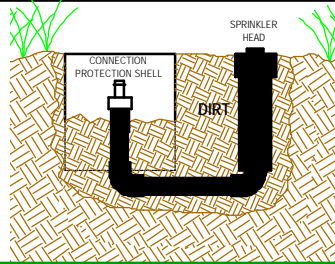

6. Attach the female "quick connect" hose connection to your garden hose.

Turn on the water to the hose. The automatic shut off will not allow the water to flow.

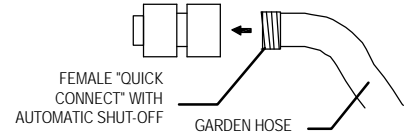

7. Click your hose onto the sprinkler

The sprinkler will pop up and begin to spray water on your lawn!

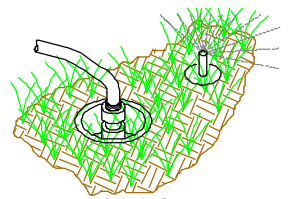

*Stand where the hose connection is between you and the sprinkler head to avoid getting sprayed. The sprinklers are set at the factory to spray away from the hose connection until re-adjusted by consumer.



NEWLY INSTALLED
(Original style shown)

WEEKS LATER
(Original style shown)

BEFORE YOU KNOW IT!
(Original style shown)

8. Aim the Sprinkler

Sprinkler Station Squared™ can mist a 9 x 18 foot rectangle, a 4 x 15 rectangle or a 4 x 30 foot rectangle.

- While the head is not spraying, unscrew the cap at the top of the sprinkler.
- Pull out the nozzle, push down the white collar and turn the gray top to the desired pattern.
- The arrow should point to the desired pattern.
- Replace the nozzle into the sprinkler case, aiming the arrow directly away from the hose connection.

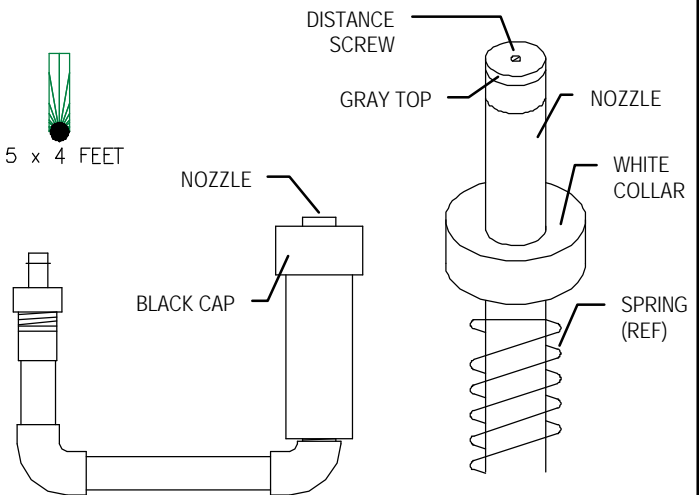
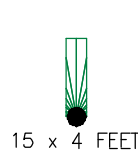

To reduce the Spray Distance

Use a screwdriver to turn the distance screw on the top of the sprinkler

9. Unplug the hose to let the sprinkler head collapse to ground level.

The automatic shut off stops the water flow while you walk to the next sprinkler or to turn off the water and store the hose.

Place the cover on the connection protection shell when the sprinkler is not in use...

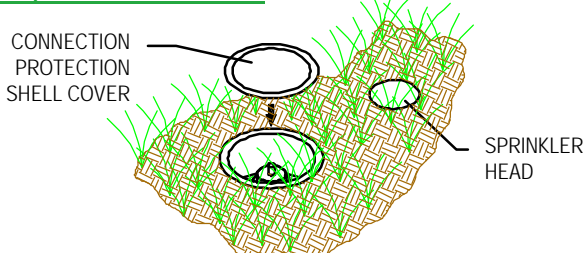

Warranty

Watering Made Easy Sprinkler Stations carry a replacement warranty for five years from date of purchase with receipt. Watering Made Easy will replace the product if it is found to have a manufactured defect due to material or workmanship. This warranty does not extend to damage due to misuse, neglect or abuse, debris/sandy water, freezing, normal wear and tear, or accident. Under no circumstances will Watering Made Easy be liable for incidental or consequential damages. All implied warranties are limited in duration to five years following purchase. Depending on the state you reside in, the above limitations may not apply to you. If any problems arise with a Watering Made Easy Sprinkler Station please call toll free 1-877-280-4485.

Sprinkler Stations installed in freezing climates require "Winterizing" to prevent damage by water freezing and expanding inside of the sprinkler. The 7-10 ounces of water that remains in the sprinkler after use must be pumped out before it can freeze and damage the sprinkler. We offer a "Winterizer Kit" that includes a trigger sprayer to remove the water and a small plug to place in the hose connection to prevent new water from entering, or you may choose to use your own method to remove the water..